

## Geometry Induced Biofilm Formation

Ana Carpio<sup>\*1</sup>, and David R. Espeso<sup>2</sup>

<sup>1</sup>Departamento de Matemática Aplicada, Universidad Complutense de Madrid, Madrid 28040, Spain, <sup>2</sup>Centro Nacional de Biotecnología, CSIC, Spain, 28049

\*Corresponding author: carpio@mat.ucm.es

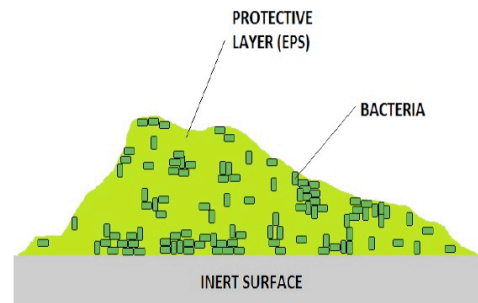
**Abstract:** Bacteria in aqueous environments usually gather to form aggregates called biofilms. In biofilms, cells display many behavioral differences from planktonic cells, such as a 1,000-fold increase in tolerance to antibiotics. Hospital-acquired infections are often caused by biofilm spread through medical systems. Design improvements hindering biofilm formation rely on identifying factors that favor their appearance. Geometry variations in medical flow circuits may trigger biofilm nucleation through vortical motion driving bacteria to walls. Detailed flow studies in mili and microfluidic devices support that observation. Once biofilm seeds are created, they proliferate forming filaments whose structure is again controlled by the geometry.

**Keywords:** Biofilms, flows, hospital acquired infections.

### 1. Introduction

Biofilms are the dominant habitat of bacteria in nature: clusters formed by bacteria attached to each other and to a moist surface, enveloped by a polymeric matrix produced by bacteria themselves [1,2], see Figure 1. In their biofilm form bacteria are extremely resistant to external aggressions by chemicals, disinfectants, antibiotics and flows. For that reason, biofilms are a main cause of hospital acquired infections [1].

Most antibiotics have been designed to target floating bacteria. Survivors are then eliminated by our immune system. In biofilms, the polymeric matrix prevents the immune system from eliminating survivors. A chronic infection develops. Antibiotics do not succeed in killing all bacteria for a variety of reasons [2]. They may fail to penetrate deep inside the biofilm through the polymeric matrix. Bacteria within the biofilm may mutate, avoiding the antibiotic action.



**Figure 1.** Schematic representation of a biofilm. A polymeric matrix formed by exopolysaccharides (EPS) envelops bacteria attached to a moist surface.

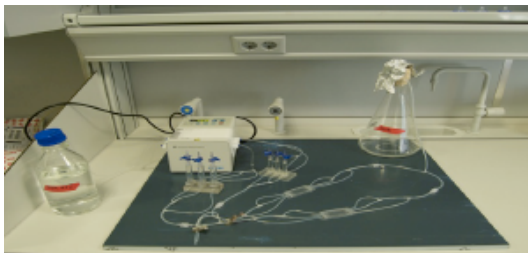
Hospital acquired infections are the result of a vicious cycle. Microbes live in the hospital environment, on the patient himself and on the medical equipment. The medical staff and invasive devices act as vehicles that introduce microbes inside the body. Most hospital acquired infections are triggered by implants: artificial joints, vascular grafts, heart valves, catheters... As the life expectancy increases, the possibility of requiring medical implants grows. 7% more implants are performed every year. This results in an increasing number of infections, specially in immunocompromised patients (about 2 million a year in the USA), huge economic costs for the health care system, and a percentage of avoidable deaths [3]. Understanding how the design of medical equipment influences biofilm nucleation and growth may help to reduce this trend.

The role of the geometry in biofilm nucleation in flow circuits has been pointed out in Ref. [4,5]. Experimental studies in laminar corner microflows show that biofilms nucleate at corners, forming filaments that cross the mainstream [4,6]. COMSOL studies of the structure of the flow relate this fact to the presence of secondary vortices driving floating bacteria to the walls [4]. Experimental and numerical studies also show the formation of helical biofilm threads past narrowings [5],

driven by vortices. Studying the structure of the flow, we may infer which geometrical features trigger biofilm nucleation. The shape of the resulting biofilm filament is decided by the interaction of the flow with the growing elastic thread [6,5]. Coupling simulations of corner flows with cellular automata descriptions of aggregation processes, 3D structures crossing the mainstream are generated [7]. More realistic descriptions of the process consider the biofilm a thin filament interacting with the flow [6,5]. COMSOL studies of flows in specific geometries combined with MATLAB simulations of filaments actuated by the flow [6,5,8,9] provide a flexible tool to predict biofilm nucleation and spread in flow circuits. Instead, predictions of biofilm spread over surfaces relies on plate deformation analysis [10]. We focus here on analyzing geometric features that may trigger biofilm formation in flows.

## 2. Governing equations

Medical flow circuits usually consist of networks of tubes, with a diameter of a few millimeters, that circulate fluids carrying mixtures of substances from a reservoir into a patient. Figure 2 illustrates a simple lay out. The flow is set in motion through a drip mechanism, or a roller pump, that induces slow pulsatile flows not harming cells.



**Figure 2.** Lay-out for a standard circuit, formed by a reservoir, a pump and a network of interconnected tubes.

Typical alterations of the tube cylindrical geometry occur at junctions, to split or merge branches (T-junctions), to connect conduits of different diameters, or to attach tubes to different elements of the circuits. Our simulations target regions where the cylindrical shape is altered. The fluid flow in the selected geometry is

governed by the incompressible Navier-Stokes equations:

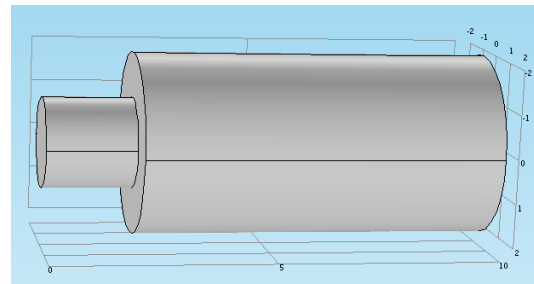
$$\rho \frac{\partial \mathbf{u}}{\partial t} - \nabla \cdot \eta (\nabla \mathbf{u} + (\nabla \mathbf{u})^T) + \rho \mathbf{u} \cdot \nabla \mathbf{u} + \nabla p = 0$$

$$\nabla \cdot \mathbf{u} = 0$$

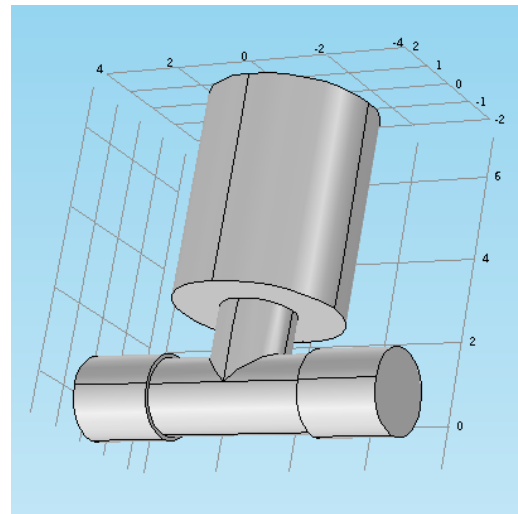
where  $\mathbf{u}$  denotes the velocity (m/s),  $p$  the pressure (Pa),  $\rho$  the density ( $\text{kg/m}^3$ ) and  $\eta$  the viscosity ( $\text{N.s/m}^2$ ). Neglecting viscosity and density variations due to the presence of bacteria and chemicals in the fluid we will set the viscosity equal to  $10^{-3} \text{ N.s/m}^2$  and a density of  $10^3 \text{ kg/m}^3$ . On the walls of the tube we impose no slip boundary conditions:  $\mathbf{u} = \mathbf{0}$ .

## 3. COMSOL Model and Results

The basic geometries under study are conduits of varying diameters, as in Figures 3 and 4, where tubes of 2 mm and 4 mm are connected.

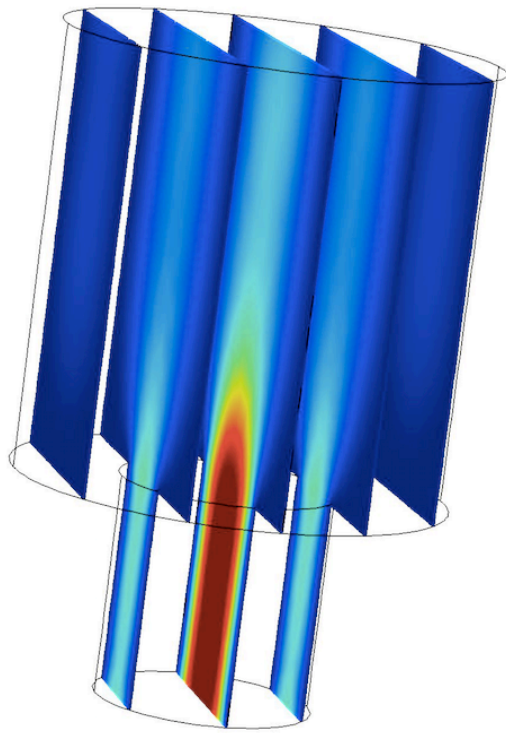


**Figure 3.** Straight connection between tubes of different diameters.

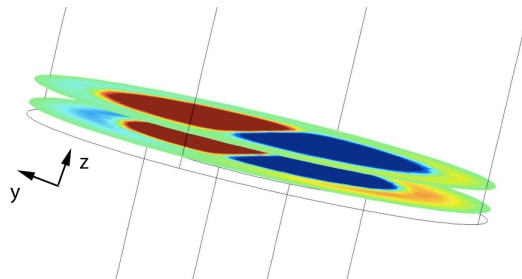


**Figure 4.** T-junction used to merge or split conduits.

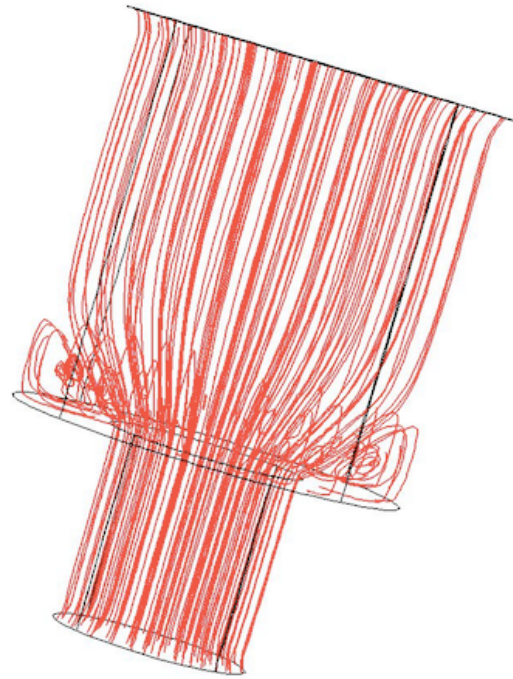
Typical maximum flow velocities are 1 mm/s. Reynolds numbers are of order one. The flow is described by a laminar regime, and set in motion by a pressure drop, imposed through a pressure jump between inlet and outlet. The velocity component  $w$  in the direction parallel to the tube walls develops a typical Poiseuille profile after the narrowing, see Figure 5.



**Figure 5.** Slices depicting the spatial variation of the  $w$  component of the velocity (parallel to the wall) past the narrowing represented in Figure 3. The velocity modulus shows a similar profile.



**Figure 6.** Slices indicating the sign of the velocity in the direction  $y$ , orthogonal to the walls, which suggests recirculation in the vortex region. Colors evolve from blue (negative) to red (positive).



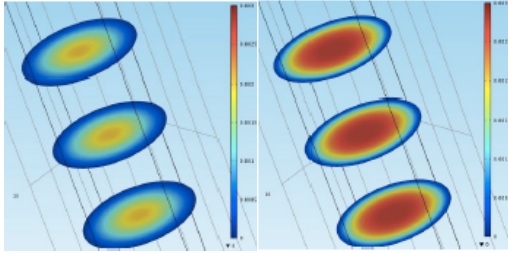
**Figure 7.** Streamlines illustrating vortex formation past the narrowing depicted in Figure 3. Floating bacteria are driven to the walls forming biofilms.

The magnitude of the components of the velocity in the direction orthogonal to the walls is 10 times smaller. However, a careful study shows changes of sign past the narrowing, which indicates recirculation, see Figure 6. Depicting the streamlines, we observe streamline expansion and the appearance of vortices, see Figure 7. Floating cells may be trapped by these eddies and driven to the walls of the tubes. Those areas become preferential sites for biofilm nucleation.

Figures 5-7 correspond to a constant drop pressure, that creates a steady flow. A pulsatile flow can be simulated by imposing a periodic drop. A similar structure is observed, but the magnitude of the velocity components increases and decreases periodically, see Figure 8. The vortices undergo slight periodic expansions and contractions too.

Once the microorganisms reach the walls, successful attachment depends on the material forming the tubes and the bacterial strain. When a biofilm seed is created, it is shaped by the current, producing threads elongating

downstream. As these threads become longer, they interact with the flow, adopting different equilibrium shapes [6,5]. The spread of the biofilm threads can be described by means of rod models that compute the evolution of a filament subject to the forces exerted by the flow [6,5]



**Figure 8.** Fluctuations of the velocity modulus along the tube at different instants of a period of a pulsatile flow.

## 5. Conclusions

Detailed studies of the flow structure in specific geometries may predict preferential sites for biofilm nucleation in medical flow systems, usually regions where vortices perturbing the primary laminar flow and driving particles to walls are formed. Combining flow simulations with elastic rod descriptions we may predict the spread and structure of nucleated biofilm filaments.

Tube geometry variations, such as narrowings and corners, should be avoided in medical circuits to reduce the risk of biofilm nucleation. If unavoidable, antimicrobial protocols should target them.

## 6. References

1. K. Vickery, H. Hu, A.S. Jacombs, D.A. Bradshaw, A.K. Deva, A review of bacterial biofilms and their role in device-associated infection, *Healthcare Infection*, **18**, 61-66 (2013)
2. N. Hoiby, T. Bjarnsholt, M. Givskov, S. Molin, O. Ciofu, Antibiotic resistance of bacterial biofilms, *Int. J. Antimicrob. Agents*, **35** 322-332 (2010)
3. P.W. Stone, Economic burden of healthcare-associated infections: An American perspective,

*Expert. Rev. Pharmacoeconomics Outcomes Res.*, **9**, 417-422 (2009)

4. R. Rusconi, S. Lecuyer, L. Guglielmini, H.A. Stone, Laminar flow around corners triggers the formation of biofilm streamers, *J. R. Soc. Interface*, **7**, 1293-1299 (2010)

5. D.R. Espeso, A. Carpio, E. Martinez-Garcia, V. de Lorenzo, Stenosis triggers spread of helical *Pseudomonas* biofilms in cylindrical flow systems, *Scientific Reports* **6**, 27170 (2016)

6. N. Autrusson, L. Guglielmini, S. Lecuyer, R. Rusconi, H.A. Stone, The shape of an elastic filament in a two-dimensional corner flow, *Phys. Fluids*, **23**, 063602 (2011)

7. A. Carpio, B. Einarsson, D.R. Espeso, Dynamics of bacterial aggregates in microflows, ECMI 2014, eprints.ucm.es

8. M. Bergou, M. Wardetzky, S. Robinson, B. Audoly, E. Grinspun, Discrete elastic rods, *ACM Transactions on Graphics*, **27**, 63 (2008)

9. D. Rodriguez, B. Einarsson, A. Carpio, Biofilm growth on rugose surfaces, *Physical Review E*, **86**, 061914 (2012)

10. D.R. Espeso, A. Carpio, B. Einarsson, Differential growth of wrinkled biofilms, *Physical Review E*, **91**, 022710 (2015)

## 7. Acknowledgements

Research supported by grant No. FIS2011-28838-C02 of the spanish MICINN.